

Q2i

Fingerprint Color Door Access & Time Attendance

User Guide

CONTENTS

- 3-4 CHAPTER 1 • GETTING STARTED**
Viewing the User Guide in the Internet
Terminal Included Accessories
Included Printed Materials
Activating Terminal
Registering Terminal
- 5-8 CHAPTER 2 • BASICS**
Introduction to Terminal
Terminal Overview
Main Menu
Power On/Off Button
Battery
Date/Time
Voice Control
Security Features
Cleaning Terminal
Restarting and Resetting Terminal
- 9-12 CHAPTER 3 • USER**
Enrolling User
Verifying User
Adding User Information
Deleting User
Access Level/Privilege
Defining Work Codes
RFID Card Function
- 13-17 CHAPTER 4 • INSTALLATIONS & CONNECTION**
Installations
Communications
Security
Ingress Online Activation
Installation and Setup of Ingress
Connecting Terminals to Ingress
Using USB to Download/Upload Data
Communication Key
- 18-21 Chapter 5 • SYSTEM**
System Settings
Data Management
Data Update Using USB Flash Disk
Keyboard
Display Settings
Reset
Misc Settings
- 22 CHAPTER 6 • DATE/TIME**
Setting Date/Time
Daylight Saving Time
- 23 CHAPTER 7 • USB**
Understanding the Need for USB
- 24 CHAPTER 8 • AUTO TEST**
Who should do the Auto Test?
- 25 CHAPTER 9 • RECORD**
Checking Records of Users in the Terminal
- 25 CHAPTER 10 • SYSTEM INFORMATION**
Records
Device
- 26-27 TROUBLESHOOTING**

1 • GETTING STARTED

Viewing the User Guide in the Internet

The User Guide is available in the package when you purchased the terminal. The User Guide is also available online at fingertec.com and user.fingertec.com. Choose the language that you prefer for your User Guide.

Terminal Included Accessories

Do not abuse the fingerprint sensor by scratching the surface, contacting the sensor's surface with heat, pressing hard during placement of fingerprint for verification. Clean the sensor occasionally with microfiber cloth to maintain the performance of the sensor.

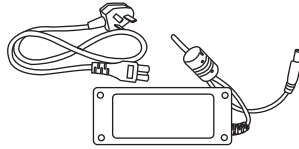
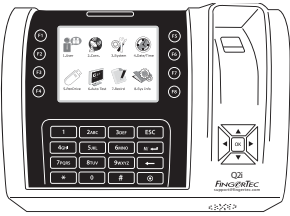

DC 12V Power Adaptor

Connect the power adaptor to the terminal and plug it into a standard power outlet to charge the terminal.



USB Extension

To connect to the USB port of a computer for uploading and downloading of data.

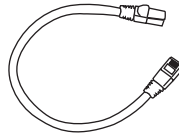

Cat 5 Cable

Connect the CAT5 to the terminal and another end for LAN connection.

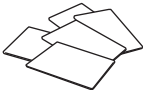

RFID Cards (5 pieces)

For card enrollment and verification.



Screwdriver

Use the screwdriver to open the back plate of fingerprint terminal and to install the back plate against a wall.



A Packet of Bolts

Use the screws to hold the back plate of the terminal against a wall.

Included Printed Materials

- FingerTec Comprehensive DVD
- Quick Start Guide
- Pamphlet
- User Enrollment Template Form
- Warranty Card

Activating Terminal

Every FingerTec access control model comes bundled with a unique license key. To start using the terminal with Ingress, you must connect the terminal to Ingress and perform online activation. Ingress reads the serial number of your terminal and sends it for verification at the FingerTec server via Internet.

In case you do not have an Internet connection, you would need to do offline activation. Please send the serial number and models of your terminals to your local resellers or support@fingertec.com to request for a product key and activation key.

Registering Terminal

Make sure that you register your terminal's warranty with us at fingertec.com/ver2/english/e_warranty.htm.

2 • BASICS

Introduction to Terminal

FingerTec is a renowned brand name for commercial products for door access and time attendance systems. FingerTec offers a wide range of products to cater to the growing needs for biometrics products in office/home automation as well as in security industry.

FingerTec terminals are loaded with powerful microprocessor that can process biometrics authentication methods for accurate personal identifications and for collection of precise data for time attendance. In addition, some fingerprint terminals are made to accept card verification as an added security measure.

This manual covers color time attendance models of FingerTec products from AC100C, TA100 and TA200 Plus model. The terminal acts as a tool to collect attendance data. For a processing of attendance data, FingerTec is providing a powerful time management software, Software to process data and provide accurate and reliable attendance reports.

Terminal Overview

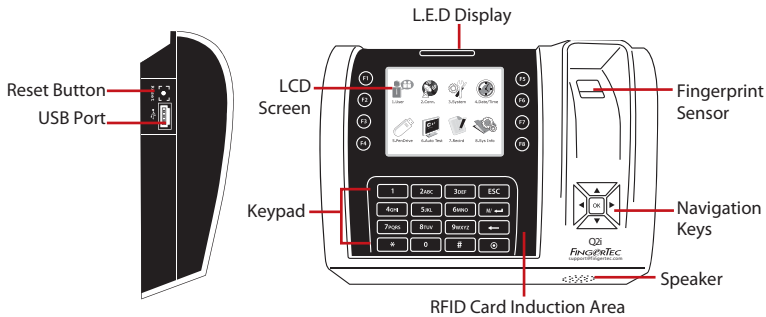

ITEM	FUNCTION
LCD Screen	Displaying status of terminal, day, date and time.
LED Display	Green LED – The terminal is working fine and it is in standby mode. Red LED – There is an error at the terminal that requires checking. For first time use, the terminals need to be charged fully to avoid having the red light blinking.
Keypad	To input instructions into the terminal and to allow configuration.
Navigation Keys	To navigation and input command to terminal.
RFID Card Induction Area	Area that reads RFID cards.
Speaker	For terminal voice emission.
Reset Button	To restart the terminal as and when required.

Main Menu



1. User

Enroll users, manage user data and input workcode.



5. PenDrive

Upload and download data and information to and from the FingerTec terminal using a USB flash disk.



2. Comm.

Setup FingerTec terminal communication with computer through LAN, RS232 and RS485. Set security password of the device for a secure data transfer.



6. Auto Test

Run tests on the FingerTec terminal to diagnose the terminal on various aspects.



3. System

Configure the settings of the FingerTec terminals from general to display setting to fingerprint. Data management, update via USB flash disk, keyboard functions, reset and other terminal settings can be done here.



7. Record

Check user attendance and transaction logs that are available in FingerTec terminals and perform housekeeping of the machine.



4. Date/Time

Adjust the date and time settings of the terminal.



8. Sys Info

View free and used memory of the terminal as well as the terminal's details in system information.

Power On/Off Button

Use the power on/off button to turn the terminal on or off. You can disable the button to avoid accidental shut off of the terminal.

Battery

Terminals operate using power supply from a standard power outlet. Inside the terminal, there is an RTC battery for the running of the clock. Charge the terminal for at least 3 hours straight before you start using it. When there is a serious delay in time or the clock keeps on restarting, the RTC needs to be replaced. **External power supply:** Mini UPS (uninterrupted power supply) 5V and mini UPS 12V provide mobile power supply to the terminals. Charge the mini UPS sufficiently for optimum performance. Refer to accessory.fingertec.com for more information about accessories.

Date/Time

The terminals display the date and time at the home screen. Choose the date and time format based on your preference. Press Menu > Date/Time > Select Value > OK to save.

Voice Control

Voice Control lets you control the level of volume emitted by the terminal.

TURN ON/OFF

The system lets you to turn on/off the voice based on your preference. Press Menu > System > System > Voice > On/Off > Determine value in percentage (default is 67%) > OK to save.

ADJUST VOLUME

The default volume of the terminal's voice is 67. The volume can go as high as 100 and as low as 0. To sustain the performance of speaker, it's recommended to stay within the range of 60-70. To adjust the volume Press Menu > System Icon > System > Vol > input value > OK to save

Security Features

Security features help protect the information in the terminal from being accessed by unauthorized individuals.

ADMIN AFFIRM

Register an administrator to the system by enrolling a fingerprint or a password to a user ID. Press Menu > User Mgmt > New User > Privilege: Admin > Choose enrollment method > OK to Save. After enrolling an administrator, the main menu can only be accessed by the administrator. The terminal will display "Admin Affirm" when an unauthorized individual tries to access the Menu.

COM KEY

Create password for a specific terminal here. Press Menu > Comm. Icon > Security > Insert Terminal ID No and Password > Ok to save. The security password known as COM Key is intended for extra security. To connect the terminal with the software, the COM key inserted in the Software must be the same as the one inserted in the terminal or else the connection will not be established even though the activation key and product key are correctly inserted.

Cleaning Terminal

CLEANING THE BODY

Use a dry cloth to clean the terminal's body. Do not use any liquids, household cleaners, aerosol spray, solvents, alcohol, ammonia and abrasive solutions to clean the body of the terminal because it could damage it.

CLEANING THE FINGERPRINT PRISM

Clean the fingerprint prism with a cellophane tape for (silicon coated prism). View the video on how to clean the fingerprint prism at this link fingertec.com/newsletter/en-user/cleanfinger.html. For the non-coated prism, please use microfiber cloth.

Restarting and Resetting Terminal

If a feature isn't functioning as it should, try restarting or resetting the terminals

RESTARTING THE TERMINAL

Push the On/Off button on the terminal to restart the terminal. If you can't restart the terminal, or if the problem persists, you might want to reset.

RESETTING THE TERMINAL

Go to Menu, press the System icon and click on Reset. Choose to Reset All Default Settings, Reset Keyboard Settings or Reset Other Parameters. Resetting the terminal will cause all your settings to return to the original factory settings.

Enrolling User

The FingerTec terminals can enroll fingerprint templates, passwords and card information. This chapter covers all possible user enrollments in the terminals.

FINGERPRINT ENROLLMENT

It is recommended to enroll two fingers for one user ID. One template is the default and another one is used for backup. You need to check the quality of the fingerprint before doing any fingerprint enrollment. It is important to locate the center points of the finger because the center points has to be placed in the middle of the scanner during enrollment to get a good reading. You also have to make sure that the fingers are not too wet or too dry for enrollment. **To enroll fingerprint:** Press Menu > User Mgmt icon > New User > ID. No: (insert value) > Select “Enroll FP” > Select Privilege > Place your fingerprint 3 times following instructions given by the terminal > OK to save.

CARD ENROLLMENT

For terminals that are using card system, default card for the terminal is RFID. MiFare and HID card systems are available upon request. **To enroll card:** Press Menu > User Mgmt icon > New User > ID No: > Insert User ID > Select “Enroll Card” > Wave the card at the scanning area until the screen displays the Card ID > OK to save.

PASSWORD ENROLLMENT

The terminal offers different enrolment methods, and passwords can be used alone or in combination with other verification methods. The maximum length of a password is 8 digits. **To enroll password:** Press Menu > User Mgmt icon > New User > ID No: (insert value) > Select “Enroll Pwd” > Input password using the keypad > Reconfirm password > OK > OK to save.

Verifying User

1:1 (ONE TO ONE) / 1:N (ONE TO MANY)

VERIFICATION METHOD	PROCESS
1:1 (One to One)	You have to identify your User ID before inputting any biometrics feature for verification. For example, your user ID is 1008. One to one method requires you to key in user ID followed by your fingerprint to get verified.
1:N (One to Many)	You don't need to identify your User ID before inputting any biometrics feature for verification. Simply place your finger on the scanner for verification.

VOICE MESSAGE

VOICE / MESSAGE	WHAT DOES IT MEAN?
"Verified"	Identity verification is successful, the terminal stores the transaction logs and opens the door (if connected to door access)
"Try again please"	Identity verification is failed because the finger is not properly positioned, the template is not available in the terminal or the password is incorrect.
"Admin Affirm"	You are not an administrator of the system and you cannot access Menu page
"Duplicate Finger"	This message only appears during registration when the finger that you want to enroll has been enrolled before. "FP Enrolled Alrd" will be displayed on the LCD screen.
"Invalid ID"	For 1:1 verification, User ID entered does not match with fingerprint.

FINGERPRINT VERIFICATION

1:N – 1:N verification does not require any input of your user ID. Place your finger properly on the scanner and the terminal will take a second to verify your identity.

1:1 – 1:1 requires input of User ID before the terminal reads and verifies your identity. Press 1:1/1:N > Input ID on the screen > Press fingerprint icon > terminal will read and verify.

Some precautions have to be taken to get a good read every time.

- Make sure the center point of your finger is placed in the middle of the scanner for a good read.
- Recommended to use index finger. The terminal accepts other fingers but index is the most convenient.
- Make sure the finger is not wet, too dry, injured or dirty
- Do not press hard on the sensor, just place it comfortably
- Avoid direct sunlight or bright light



PASSWORD VERIFICATION

Password can be an option for those who do not prefer to use other verification methods. To verify using password, press 1:1/1:N > insert User ID and press key button > insert password and press OK.

CARD VERIFICATION

Place the card on the card scanning area and the terminal will read and verify the card.

Adding User Information

User information can be added into the terminal through two ways. One is through the FingerTec terminal and the other through the Software. To add/change user information via the terminal, press Menu > User Mgmt icon > Manage User > OK > Select Instruction > Edit/Add > OK to Save.

Instruction	Function
Search User	Insert User ID in the column and press OK
Record	Press to view available user records
Edit User	Delete/Add Verification Methods and change Privilege
Del User	Delete User, Fingerprint or Password
New User	Enrolment of New User

Field	Function
ID No.	Edit user ID based on your company's employee numbering system. Maximum length of user ID is 9 digit
Name	Add name of the user in this field (Can only be done via TCMS). Maximum number of characters is 24
FP	Quantity of Fingerprint
PWD	Quantity of Password
CARD	Quantity of Card

It is recommended that the updating of user information be done through the Software software. After the information is updated, sync the Software and the terminal to display the information.

Deleting User

Only an administrator can perform user deletion at the FingerTec terminal. To delete certain user(s), press Menu > User Mgmt > Manage User > OK > Select Del User > Choose "Delete User" > OK

Please be extra careful when performing this task to avoid any unauthorized deletion.

Access Level/Privilege

FingerTec terminals offer two types of access level or privilege.

PRIVILEGE	USER ROLES
Normal User	Only use the terminal to verify your identity. You cannot access into Menu and make changes into settings and system
Administrator	You are allowed to access into menu to enroll users and edit settings and system

Defining Work Codes

The terminal provides a work code feature which allows users to key in predefined numbers after verification. The work code numbers are predefined in the Software. The following table shows examples of work codes.

Press Menu > User Mgmt > WorkCode > Press ok to activate the menu > Select to Create New workcode, Edit Workcode or to Delete Workcode > Choose your preference > Ok to save.

To add work code through the terminal, Press Menu > User Mgmt > Workcode > Menu > New > Enter Code Number eg: 02 > Enter Code Name eg: Emergency Leave > OK to save.

REASONS	WORK CODE
Check In	00
Check Out	01
OT start	04
Done	05
Sick Leave	10
Half-day Leave	12
Emergency Leave	11
Meeting Client	20
Outstation	21

*Workcode Mode 1: Verification followed by work code
Workcode Mode 2: Work code followed by verification*

RFID Card Function

The fingerprint terminals are versatile and some can accept card verifications. This chapter covers the Radio Frequency Identification or better known as RFID system. The terminals accept RFID card with specifications of 64-bit, 125kHz.

ENROLLMENT OF RFID CARD

RFID can be enrolled alone, with fingerprint or with password. Each RFID card comes with a unique ID and the terminals will read from the numbers and match it with the card.

Enrollment of RFID is easy. Press Menu > User Mgmt > New User > Enroll Card > ware card at the induction area > OK.

CHANGING CARD ID

Press Menu > User Mgmt > Manage User > OK > Change Card > OK > Show a different card > OK.

4 • INSTALLATIONS & COMMUNICATION



Installations

FingerTec terminals offer several connections for power and communications. Installations of FingerTec time attendance terminals are simple.

MOUNT ON WALL

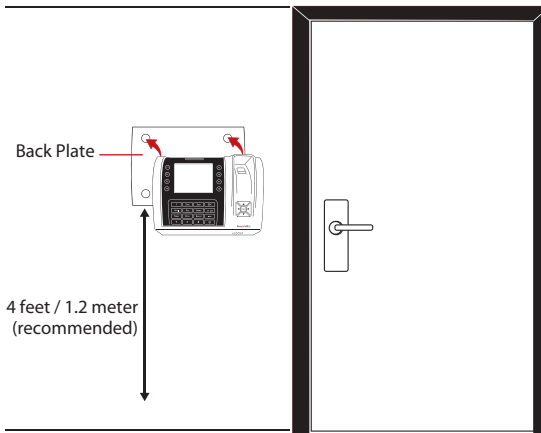

After determining the height of the terminal from the ground level and have made the relevant marks on the wall, drill the screws into the wall to hang the back plate.

FLEXI-KIT

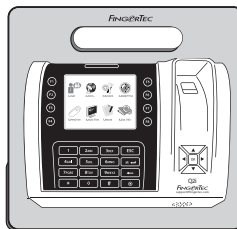

FingerTec offers flexi-kit for all its time attendance models. Attach the terminal on the flexi-kit for convenience and cosmetic purposes. View flexi-kit at accessory.fingertec.com

Communications

Connection points for power and communication are available on top of the terminals. Refer to the following diagrams for the terminals you require.

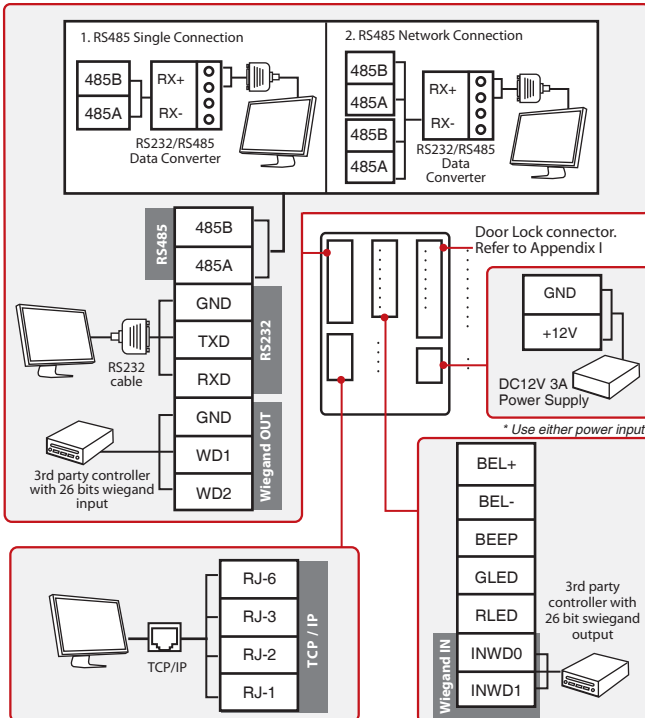
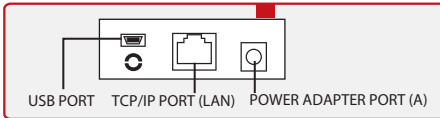
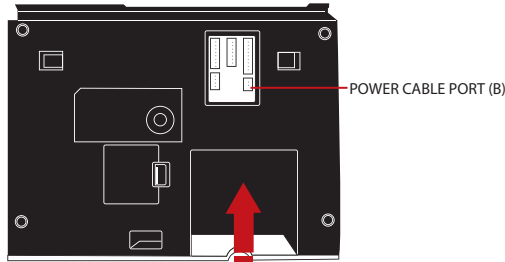

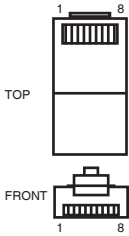

USB PORT

Linking with USB flash disk for remote data transfer.

TCP/IP PORT

Connect with CAT 5 cable for LAN connection, one end to this port and another end to the computer's TCP/IP Port.

TCP/IP for Single Connection – Linking the terminal to a single computer using TCP/IP requires Ethernet 10/100Base-T Crossover Cable. The cable can be used to cascade hubs or to connect Ethernet stations back-to-back without a hub. It works with both 10Base-T and 100Base-TX.

	JOINT 1 PIN	JOINT 2 PIN	
TX+	1	3	RX+
TX-	2	6	RX-
RX+	3	1	TX+
RX-	6	2	TX-

TCP/IP for Network Connection – Linking the terminals to multiple computers using TCP/IP requires Ethernet 10/100Base-T Straight Thru Cable or “whips”. The cable works with both 10Base-T and 100Base-TX, connecting a network interface card to a hub or network outlet.

CONNECTOR PIN	CABLE COLOR	CONNECTOR
TX+	1 White/Orange	1 TX+
TX-	2 Orange	2 TX-
RX+	3 White/Green	3 RX+
	4 Blue	4
	5 White/Blue	5
RX-	6 Green	6 RX-
	7 White/Brown	7
	8 Brown	8

POWER SUPPLY PORT

Insert the Power Adapter point to this port for power.

RS232/RS485/WIEGAND CONNECTION PORT

RS232 – Connection to a computer using RS232 cable.

RS485 Single Connection - Connection to a single computer using RS485 wire.

RS485 Network Connection - Connection to multiple computers using Daisy Chain connection.

Wiegand Output – Connecting with third party connector or terminal(s).

Security

Create password for a specific terminal here. Press Menu > Comm. > Security > Insert Terminal ID No and Password > Ok to save. The security password known as COM Key is intended for extra security. To connect the terminal with the software, the COM key inserted in the Software must be the same as the one inserted in the terminal or else connection cannot be established even though the activation key and product key are correctly inserted.

Ingress Online Activation

Ingress is a genuine software by FingerTec. Every FingerTec access control model comes bundled with a unique license key. To start using the terminal with Ingress, you must connect the terminal to Ingress and perform online activation. Ingress reads the serial number of your terminal and sends it for verification at the FingerTec server via Internet.

In case you do not have an Internet connection, you would need to do offline activation. Please send the serial number and models of your terminals to your local resellers or support@fingertec.com to request for a product key and activation key.

Installation and Setup of Ingress

Install Ingress in a PC that fulfills Ingress' minimum requirements. Refer to <http://www.fingertec.com/customer/download/postsales/SUM-Ingress-E.pdf> for the Ingress user guide online. Setup Wizard will require you to do online activation before connection establish between Ingress and terminals.

Connecting the Terminals to Ingress

DETERMINING TERMINAL NUMBER

Identify the number of your terminals to differentiate them between one another. Ingress can connect up to 999 units of terminal. Press Menu > Options > Comm Opt > Dev Num > Select the number.

USING TCP/IP

IP address is important, as it is a unique address of the terminal in LAN. Without the IP address, locating the specific terminal is not possible. **To input the IP address of the terminal:** Press Menu > Options > Comm Opt > IP Addr > Key in IP address.

USING TCP/IP

It is important to setup the Ethernet to connect the terminals using TCP/IP connection. **Setting up the Ethernet is done by enabling the Ethernet function:** Press Menu > Options > Comm Opt > Ethernet > Yes.

Turn off the terminal after you have set the Ethernet setting to Yes. Now, plug-in the network plug to the Ethernet interface and turn the power on.

Determining the Netmask, Gateway and NetSpeed: For TCP/IP connection, please configure the netmask, gateway and netspeed for the terminal.

Press Menu > Options > Comm Opt > NetMask > Insert the numbers.

Press Menu > Options > Comm Opt > Gateway > Insert the numbers.

Press Menu > Options > Comm Opt > NetSpeed > Choose the speed of your Ethernet connection.

USING RS232 CONNECTION

For connection via RS232, baudrate is the determinant of communication speed between the terminal and the software. The higher the baudrate, the faster the speed is.

To turn on RS232 connection and set the baudrate: Press Menu > Options > Comm Opt > RS232 > Change the RS232 connection to Y.

To change baudrate: Press Menu > Options > Comm Opt > Baudrate > Change the Baudrate accordingly.

USING RS485 CONNECTION

For connection via RS485, baudrate is also the determinant of communication speed between the terminal and the software but the speed must be according to the speed of the converter. Check your converter for the speed.

To turn on RS485 connection and set the baudrate: Press Menu > Options > Comm Opt > RS232 > Change the RS485 connection to Y.

To change baudrate: Press Menu > Options > Comm Opt > Baudrate > Change the Baudrate accordingly.

Using USB to Download/Upload Data

A USB flash disk is useful in cases where the terminal is installed far from a PC or there is a connection problem. To determine the type of USB flash disks compatible with the terminal, please refer to this link at fingertec.com/newsletter/HL_74.html using USB

Press Menu > PenDrive Mgmt > Choose the operation that you want to carry out via USB flash disk.

Communication Key

Since the software is controlled by an activation code and a product key, set the COMM key to zero. Press Menu > Options > Comm Opt > COMM Key > Set to 0.



System Settings

THRESHOLD

Threshold is the level of the fingerprint scanner's sensitivity. Threshold determines how many percent of minutiae points on a fingerprint template will be read by the system. The higher the threshold level, more points are being read, more restricted the system. Configure the threshold for 1:1 and 1:N methods.

For 1:1, the range is from 0-50 and the recommended value is 15.

For 1:N, the range is from 0-50 and the recommended value is 35.

Press Menu > System > System > Threshold (1:1) or Threshold (1:N) > Determine the Level > OK to Save

DATE FORMAT

The date format can differ based on countries for example in Malaysia, the date-month-year format is used while in America, the month comes first. Choose your date format according to your preference. The default format is dd-mm-yy. Press Menu > System > Date Format > Select Format > Ok to Save

SOUND OF KEYBOARD

The terminals emit sound when you press any of its buttons. **To turn on/off the keypad sound:** Press Menu > System > Keybeep > On/Off > Ok to Save

FINGER SENSITIVITY

Determine the sensitivity of the sensor to fingerprint. Choose Low, Mid or High sensitivity. It is recommended to be set at Mid. Press Menu > System > Finger Sensitivity > Select your preference > Ok to Save

VOICE

The terminal has certain voice commands to guide users during enrolment and to notify users during verification. Press Menu > System > Voice > On/Off > OK to save

VOLUME (%)

Voice Control lets you control the level of volume emitted by the terminal.

Adjust Volume: The default volume of the terminal is 60. The volume can go as high as 100 and as low as 0. To sustain the performance of speaker in the terminal, it's recommended to stay at the range of 60-70. To adjust the volume. Press Menu > System > Volume 1:100% > Set your number > Ok to Save.

ALGORITHM VERSION

Get the terminal's algorithm version here. Press Menu > System icon > System > Alg Version > View the Version > Ok to Save.

RECHECK MIN

Once you have inserted a value, eg: 1, when a user checks in at 10:01, his time will be adjusted to 10:00. The maximum value is 99. When you enter 5, a user is given 5 minutes leeway time in his attendance.

LOG ALERT

When the log storage is at a certain level, the user/administrator needs to be alerted to avoid underperformance of terminal. The recommended value is 99. Menu > System > System Settings> Log Alert > Input your value > Save

Data Management

Every time an enrolment is performed or a verification is done, a transaction log is stored inside the terminal. The data contains the terminal ID, date, time, user ID and transaction activity. For example, 01050210090000000001010000:

These logs need to be managed to maintain the effectiveness of the terminal.

It is recommended to do the housekeeping of data from the Software software. There are 4 functions available in the Data icon to enable you to manage your data in the FingerTec terminal.

DESCRIPTION	CODE
Terminal ID	01
Date (ddmmyy)	050210
Time (hhmm)	0900
User ID	000000001
Transaction Code	00
Terminal Activity	00

In the data management icon, you can choose from four instructions. Press Menu > System > Data Mgmt > Select your instruction > Ok to save

DELETING ATTLOG

Please make sure that you are certain when you want to do this operation. The logs that are stored inside the terminal are the ones that have not been downloaded into Software. Deleting the logs means that no backup data is available.

DELETING ALL DATA

This function allows you to delete all attendance data and user information in the terminal. Make sure that all user information has been backed up in the Software before performing this task.

CLEARING ADMIN

There are three user privileges in the terminals, administrator, supervisor and normal user. You can delete administrator privilege; but without an administrator, normal user can access the menu easily and interrupt the settings.

DELETING PICTURE

You can advertise your product and company corporate message in the terminal using screen saver function.

Please be extra careful when performing this task to avoid unauthorized deletion of important data

NOTE

Data Update Using USB Flash Disk

To update the terminal using a USB flash disk, press Menu > System > Update > Make sure that you have the USB Flash Disk plugged into the terminal before you proceed.

Keyboard

Define the function keys in your terminal here. Press Menu > System > Keyboard > Select the function > Determine the Key Number > Name The function (To activate the alphanumeric keyboard, press the right arrow button) > You can also set to auto switch this function on a certain time of days > Ok to Save

Display Settings

NUMBER OF TRIES

1:1 Match Retry Times: You can set the limit to the number of tries for the 1:1 verification mode. The range is from 1-9. If a user's number of tries exceeds the limit, the terminal could trigger the alarm system to alert security that somebody is meddling with the terminal. Press Menu > System > Display > 1:1 Match Retry Times > Determine the Value > ok to Save

Password Retry Times: You can set the limit to the number of tries for password verification. The range is from 1-9. If a user's number of try exceeds the limit, the terminal could trigger the alarm system to alert security that somebody is meddling with the terminal. Menu > System > Display > 1:1 Match Retry Times > Determine the Value > Ok to Save

Clock Mode: There are two clock modes available in FingerTec terminals. Choose the one your prefer. Press Menu > System > Display > Clock Mode > Choose 1 or 2 > Ok to Save

PICTURE DELAY

Picture delay refers to the idle period before the screen displays your loaded advertisement. It ranges from 0-999 seconds. Press Menu > System > Display > Picture Delay > Determine your time > Ok to Save

CLOCK DELAY

Clock delay is an idle period before the screen displays your chosen clock picture. It ranges from 0-999 seconds. Menu > System > Display > Clock Delay > Determine your time > Ok to Save

Reset

Reset allows you to perform 3 tasks:

1. Reset All Default Settings
2. Reset Keyboard Settings
3. Reset Other Parameters

Please make sure that you are certain of performing any of the tasks before proceeding to avoid loss of crucial data.

Misc Settings

SLEEP TIME

Sleep time is a period before the terminal goes to sleep mode. This setting is available as a power saving feature of the terminal. The time range is from 0-999 seconds. Menu > System > Misc Set > Sleep Time > Determine your time > Ok to Save

EXT BELL

FingerTec colour time attendance terminal models allow you to link an external bell such as siren to the system. Press Menu > System > Misc Set > Ext Bell > On/Off > Ok to Save

DISPLAY THE FINGERPRINT IMAGE ONSCREEN

The terminal offers to display a fingerprint image when doing scanning for users to understand how to place the finger properly. You can opt to show the fingerprint image. Press Menu > System > Misc Set > Fp Image > Choose Your Preference > Save

Options available include:

Fingerprint Image Display	Function
Both show	The fingerprint image is displayed on the screen during both enrollment and verification.
Neither show	The fingerprint image is neither displayed on the screen during enrollment nor during verification.
Enrol show	The fingerprint image is displayed on the screen only during enrollment.
Match show	The fingerprint image is displayed on the screen only during verification.

POWER KEY

You can disable or enable the power on/off button to avoid accidental shutdown of FingerTec terminals. **Disable/Enable:** Press Menu > System > Misc Set> LockPwrKey > On/Off > Ok to save.

SYSTEM LANGUAGE

FingerTec terminals offer various languages to match your local requirements. Maximum of 3 language packs are available in the terminal and it's set according to your request during purchase. The default language is English. Press Menu > System > Misc Set > Language > Choose your language > Save



Adjusting Date/Time

FingerTec time attendance terminal functions to record time attendance activities of employees. Precision in time and date cannot be compromised for the system to work efficiently. Adjust Date/Time according to your time zone. Press Menu > Date / Time > Select Value > Ok to Save

Daylight Savings Time

Daylight savings time (DLST) is the practice of temporarily advancing clocks so that afternoons have more daylight and mornings have less. Adjust your DLST if necessary. Press Menu > Date / Time > DLST to On and adjust the time accordingly > Ok to Save

7 • USB



Understanding the Need for USB

FLASH DISK

Communication between FingerTec terminals and a PC is very important to upload and download transaction data for time attendance and door access reports. The terminals offer a few communication options such as LAN and serial cable connections but sometimes there are scenarios that require USB (Universal Serial Bus) connectivity. USB can connect terminals with a computer for download and upload of user information and transaction logs.

TYPES OF USB

There is various type of USB available in the market. FingerTec terminals can only work with USB flash disks that support minimum Linux Kernel 2.4.x, working ideally with Imation, Transcend and Pen Drive (minimum support Linux Kernel 2.4.x) To determine the type of USB compatible with the FingerTec terminal, please refer to this link at fingerotec.com/newsletter/HL_74.html

DOWNLOADING DATA INTO USB

A FingerTec terminal is able to download data i.e. transaction logs, user information, and short messaging system into the USB Pen Drive. **To download the data:** Press Menu > PenDrive icon > Download Data. After the download process is complete, eject the USB flask disk from the terminal and connect it to your PC that has been installed with the Software software. Upload the data from the USB into Software for further processing.

UPLOADING DATA FROM USB

A FingerTec terminal is able to upload data i.e. user information, short messaging system, picture screensaver and themes into the USB Pen Drive. **To download the data:** Press Menu > USB icon > Upload Data. After the upload process is complete, eject the USB flask disk from the terminal.

UPLOADING PICTURES TO THE TERMINAL

The FingerTec terminals are able to display advertisements or pictures on the screen during an idle period. The size of the displayed picture must be 320 x 240 resolution.

8 • AUTO TEST



Who Should do the Auto Test?

Auto Test page is to diagnose or analyze the conditions in the terminal. There are several tests available in the Auto Test page and only an administrator is allowed to perform the test. Before running any tests, kindly contact your reseller for advice or you could email support@fingertec.com.

TFT TEST

Test Screen determines the quality and sensitivity of the terminal's touch screen panel. You will see lines of different colours; click the screen to continue testing. If there's a broken line or distorted colors on the screen, kindly send your FingerTec Terminal for repair. **To run test** : Press Menu > Auto Test icon > TFT Test

AUDIO TEST

Audio Test determines the quality of the terminal's audio. Every click on the screen will emit different voice message. If you find any distorted sound in any of the voice messages or instructions, kindly send your terminal for checking and repair. **To run test** : Press Menu > Auto Test icon > Audio Test.

KEYBOARD TEST

The Keyboard Test is for you to check the condition of the keyboard. Press Menu > Auto Test icon > Keyboard Test

SENSOR TEST

This test is to determine the condition of the fingerprint optical scanner you need to run fingerprint test. Once you run the sensor test, the terminal will display a white square on the screen. Place your finger on the scanner. If you can see your fingerprint on the white square, the optical scanner works fine. Otherwise, kindly send your terminal for checking and repair. **To run test** : Press Menu > Auto Test icon > Sensor Test

RTC TEST

Time is an essence in any FingerTec terminal and it should not be compromised. The RTC Test will display date, time, 0 (s): 0 (ms)

Click the screen to start the test. The 0 (s): 0 (ms) will start to run and every 10ms change the second to 1. If it doesn't run as it should, kindly send your terminal for checking and repair. **To run test** : Press Menu > Auto Test icon > RTC Test

9 • RECORD



Checking Records of Users in the Terminal

To view a particular user's records in the terminal, Press Menu > Record > Insert ID No:
> Select start and end range date > Ok to view

10 • SYSTEM INFORMATION



This option under System allows the installer to check the information of the terminal including storage, firmware, algorithm, etc. To retrieve the System Information of the terminal Press Menu > Sys Info.

Records

Shows free storage and used storage of the terminal, and details of user counts, admin counts and password users. It also displays other information such as FP templates and logs templates that have been used and are available.

Device

Pressing "Device" displays the terminal name, serial number, MAC Address, fingerprint algorithm, firmware version, manufacturer and manufactured date and time.

TROUBLESHOOTING

“UNABLE TO CONNECT” APPEARS

When this message appears, it means that the settings for the terminal and the computer are not properly done. Find out which method you are using to connect. The terminal offers LAN, RS232, RS485 and USB communication methods. Refer to Chapter 4 to further understand the topic.

“ADMIN AFFIRM” APPEARS

You are not the administrator of this terminal. Only an authorized administrator of the system is allowed to access the Menu. Any attempt of normal user to access the Menu will prompt “Admin Affirm” message on the screen. In case the administrator or he/she has resigned from the company, kindly contact your FingerTec authorized reseller to access the terminal.

DIFFICULT TO READ FINGER

Five things could be the cause of this:

Enrolment is not properly done: Enrolment is the most important process to ensure that the terminal captures the best quality of your fingerprints. Refer to chapter 4 for how to do a good enrollment.

The location of the terminal is not conducive: The scanner does not work well in bright-lighted area. Cover the scanner a little if this is the cause of the difficulty. Shift the location area for a better performance.

Finger is not properly placed: To get a good read, make sure that your finger’s center points are located at the middle of the scanner. Adjust the position of your fingerprint as you see it onscreen.

The scanner is not cleaned or it is scratched: Check the quality of the scanner. If the scanner is dirty, please clean it with a microfiber cloth. If it is scratched, contact your local reseller for a replacement.

Did anything happen to your finger lately? Make sure that the finger is not injured, cut or bruised which could cause it difficulty to read. The algorithm reads the minutiae points of your fingerprint, the more it can read, the better the result.

THE LED IS BLINKING ALL THE TIME

You have nothing to worry about unless the blinking light is red. The green blinking light is indicating that the terminal is under its standby mode. Red blinking light may signal problem in the terminal. Contact your reseller for consultation.

“DUPLICATE FINGER” APPEARS

FingerTec terminals are intelligent. It will not accept the same fingerprint twice into its system. If you have registered a finger into the terminal, the system would prompt “duplicate finger” when you try to enroll that finger for another time. Choose a different finger to proceed.

RFID CARD DOESN'T RESPOND

Two possibilities for this problem

Have you registered the card to the terminal?

The card must be registered to the terminal before it can read the information in the card. Refer to chapter 3 User for card enrolment.

Have you assigned the user ID to the verification group that supports RFID card?

Without setting the terminal to show that you are under a group that supports RFID card, the terminal wouldn't read your card.

NO SOUND

A few things could cause this problem:

The terminal voice mode is silent

Perhaps someone has turned off the voice in your terminal or reduced its volume to 0%. Refer to Chapter 5 System under Voice to rectify.

Speaker is damaged

Once you have rectified the voice mode, if the problem persists, proceed to test the voice. Go to Chapter 8 to do the test. If no voice is being emitted, contact your local reseller for support.

For more troubleshooting, go to user.fingertec.com

OTHER RESOURCES

Information About FingerTec

TO LEARN ABOUT	GO TO?
Company and the products	www.fingertec.com
The latest updates	Facebook Fan Page: FingerTec Worldwide Twitter: FingerTec To subscribe for FingerTec newsletter: info.fingertec.com/subscribenewsletter
Technical Tips and Latest Product Updates and Upgrades	user.fingertec.com
Email	info@fingertec.com (Sales) support@fingertec.com (Technical)
Register for Warranty	info.fingertec.com/productwarranty
FingerTec Accessory	accessory.fingertec.com

Copyright Notice & Disclaimer

COPYRIGHT NOTICE

All rights reserved. No part of this book may be reproduced or transmitted in any form or by any means, electronic or mechanical, including photocopying, recording, or by any information storage and retrieval system, without written permission from FingerTec Worldwide Sdn Bhd. Every precaution has been made to supply complete and accurate information. Information in this document is subject to change without prior notice.

DISCLAIMER

No person should rely on the contents of this publication without first obtaining advice from a qualified professional person. The company expressly disclaims all and any liability and responsibility to any terminal or user of this book, in respect of anything, and of the consequences of anything, done by any such person in reliance, whether wholly or partially, upon the whole or any part of the contents of this book.

FINGERTEC WORLDWIDE SDN BHD

